

FEATURES:

PILETTA SCARICO LIBERO H90
 SPARE PARTS FREE WASTE WATER DRAIN

TECHNICAL DRAWINGS (DIMENSIONS IN MM)

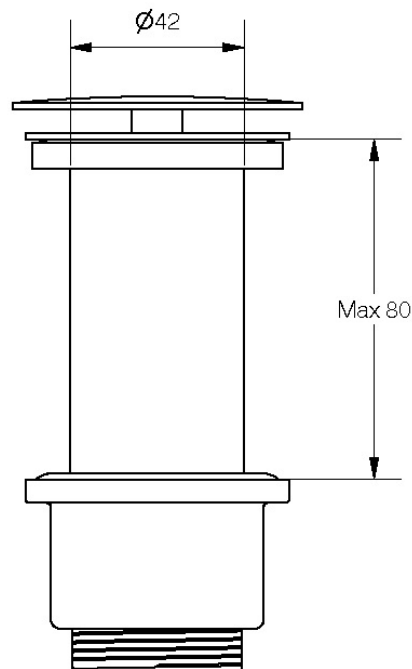

LINEABETA SPA
 SS 11, KM 331
 36053 GAMBELLARA (VI) ITALY
 TEL +39 0444644644
 FAX +39 0444644600

WWW.LINEABETA.COM

LINEABETA SPA si riserva in esclusiva i diritti di modificare le dimensioni, caratteristiche tecniche, design dei suoi prodotti, senza preavviso. Tutte le dimensioni sono indicative e potrebbero variare in conformita degli standard europei.

LINEABETA SPA reserves the exclusive right to modify dimensions, technical characteristics and aesthetic design of its productys, without prior notification. all dimensions are indicative and may vary to conform to european standards.

