

Installationsguide Flexx Plus Ret hjørne.

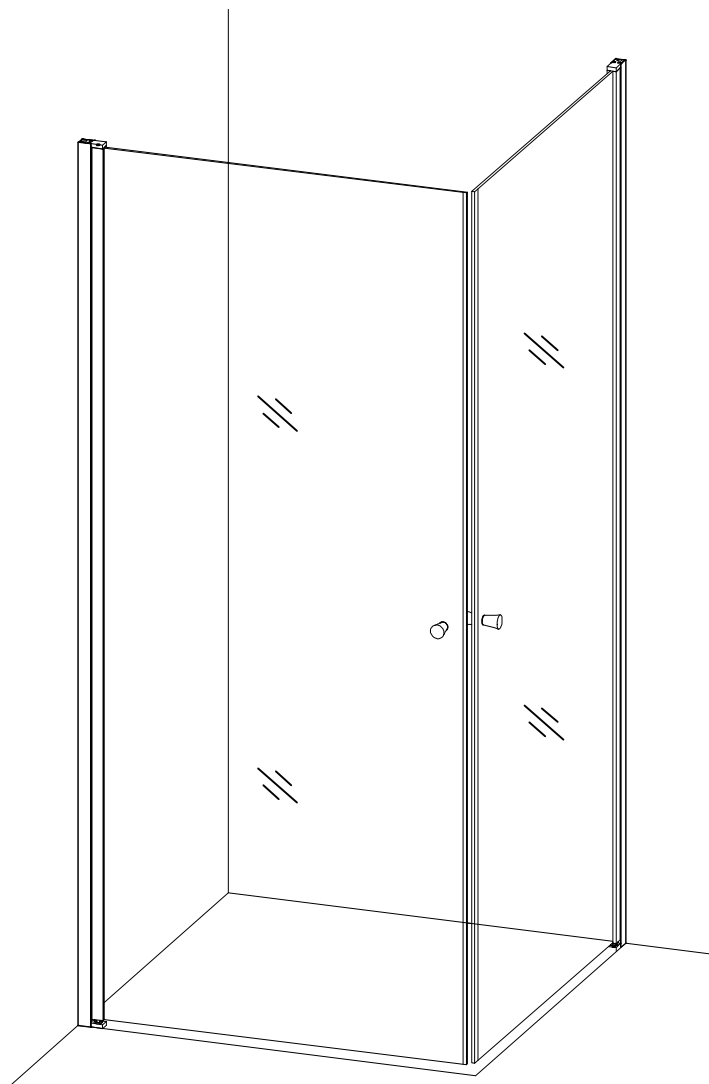

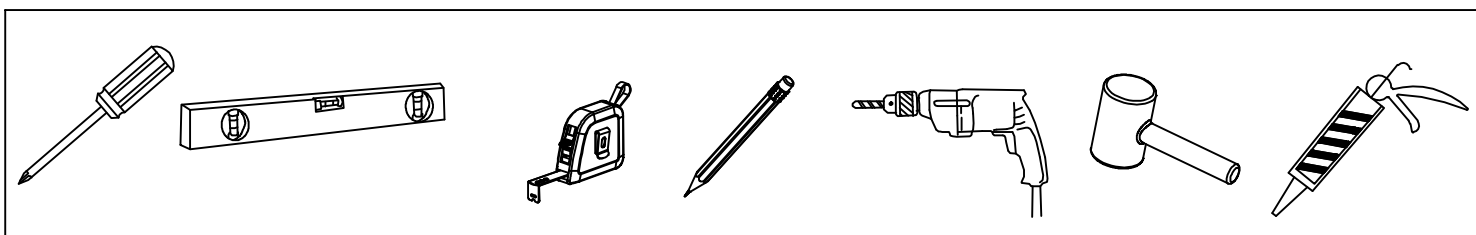

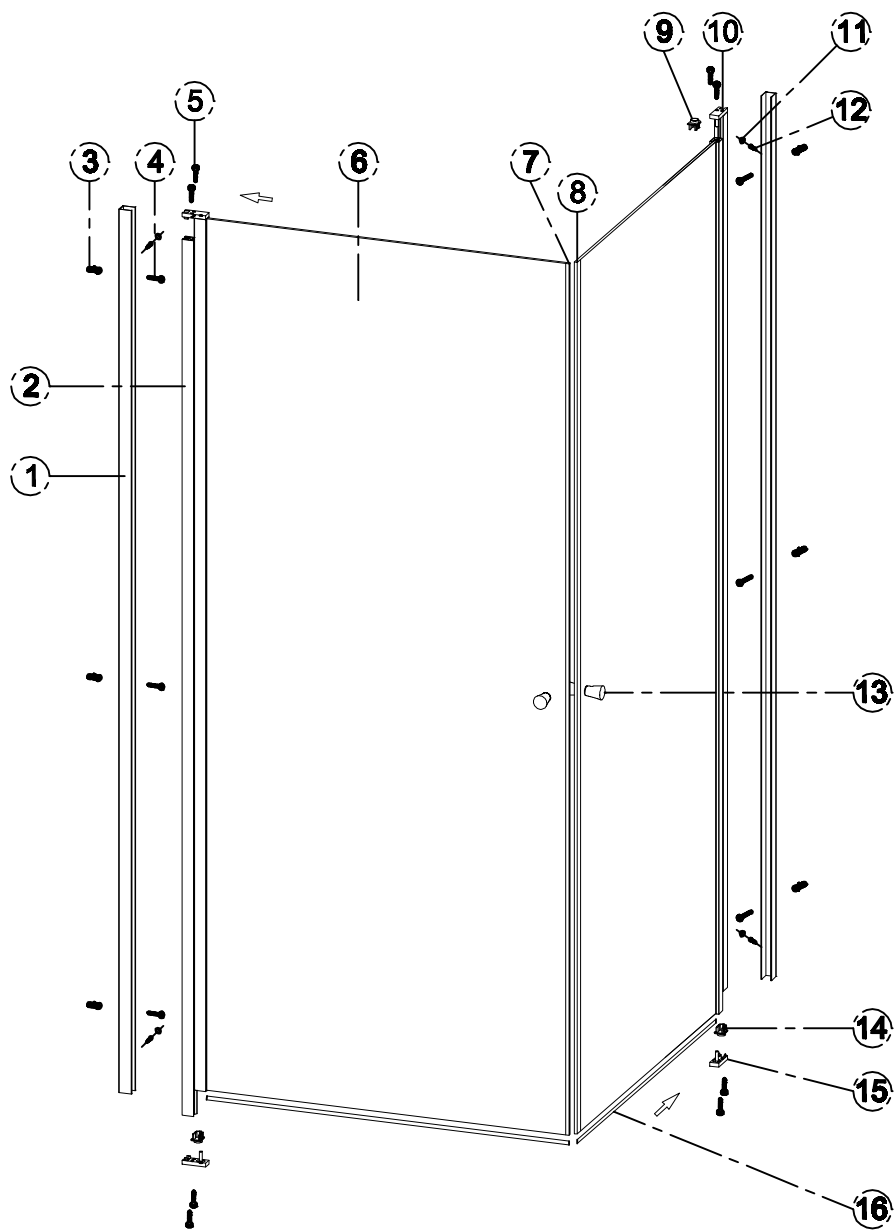













Cassøe A/S
Taksvej 24
7400 Herning
Tlf. 97127400
www.cassoe.dk





Description

1  2X	2  2X	3  6X	4 ST4*35  6X	5 ST3.5*30  6X	6  2X	7  1X	8  1X	9  2X
10  2X	11  4X	12 ST4*10  4X	13  1X	14  2X	15  2X	16  2X	17  2X	18

Monteringsmål udvendig vægprofil.

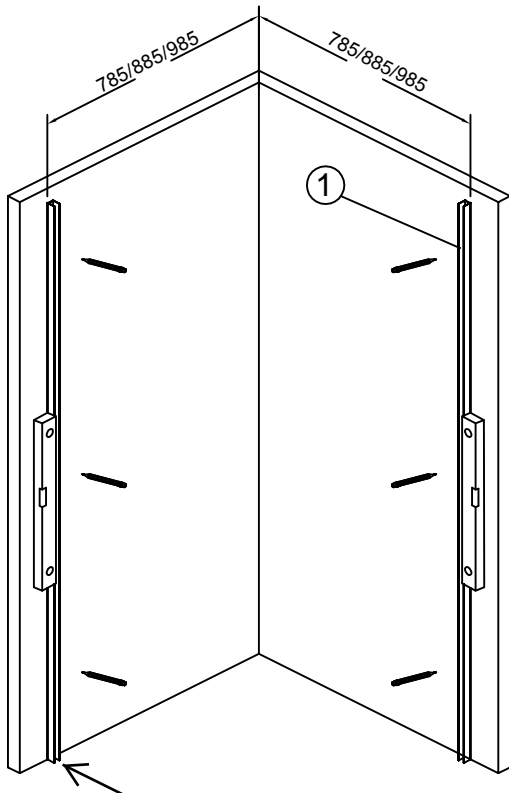

Vægprofiler i samme monteringshøjde.

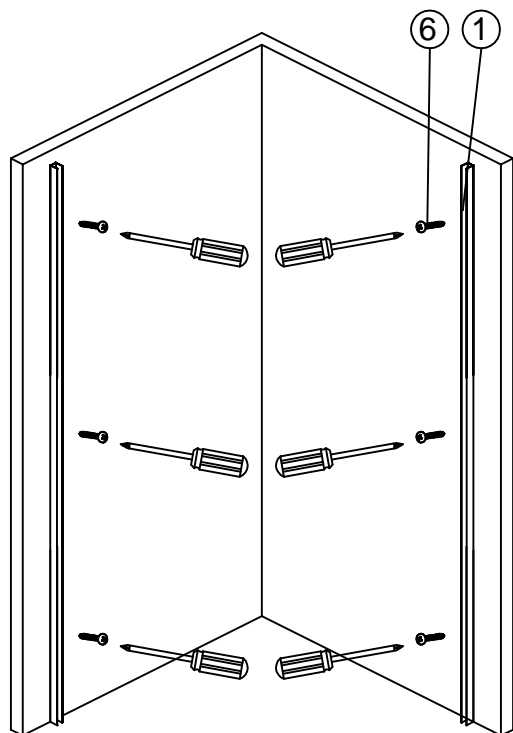
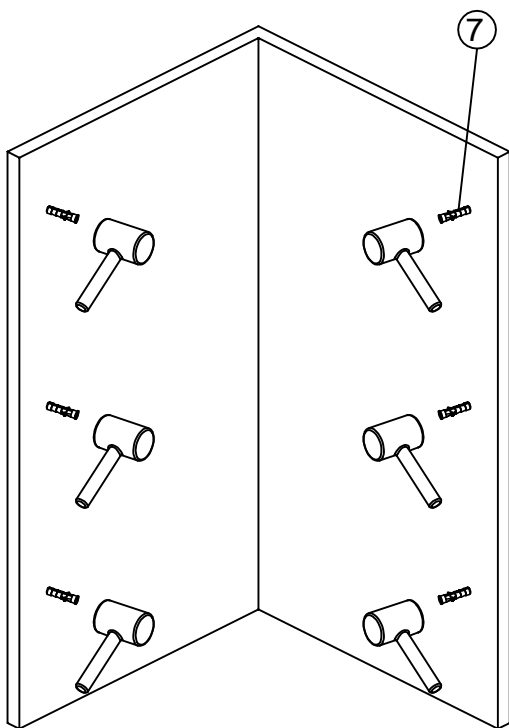
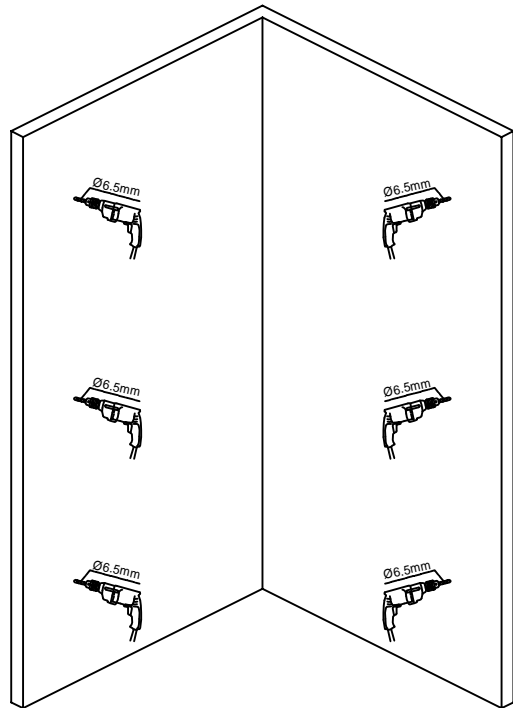

5

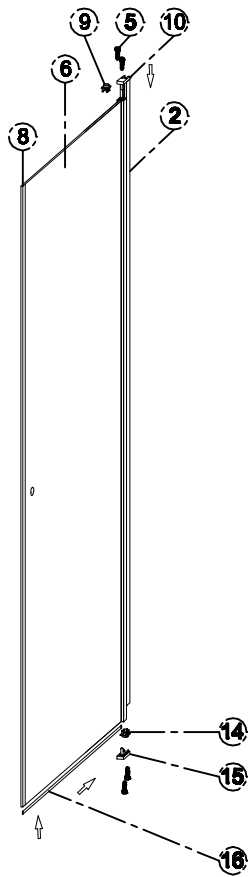

6

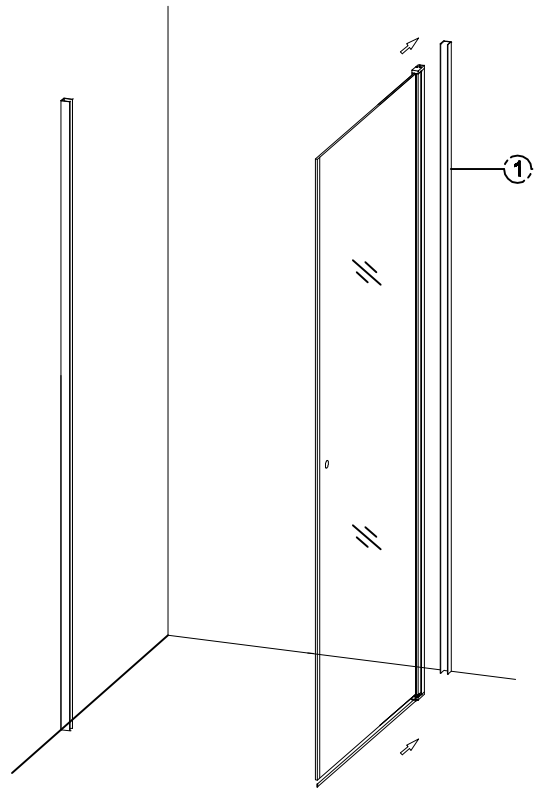

7

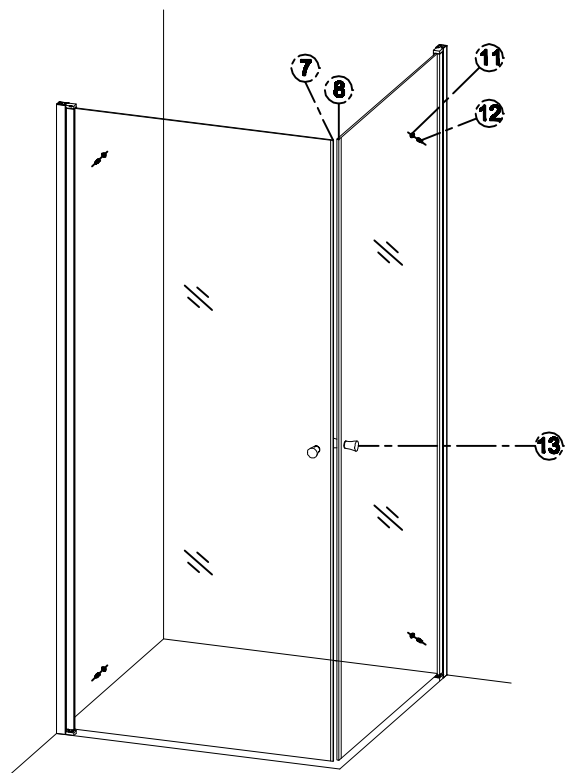

8

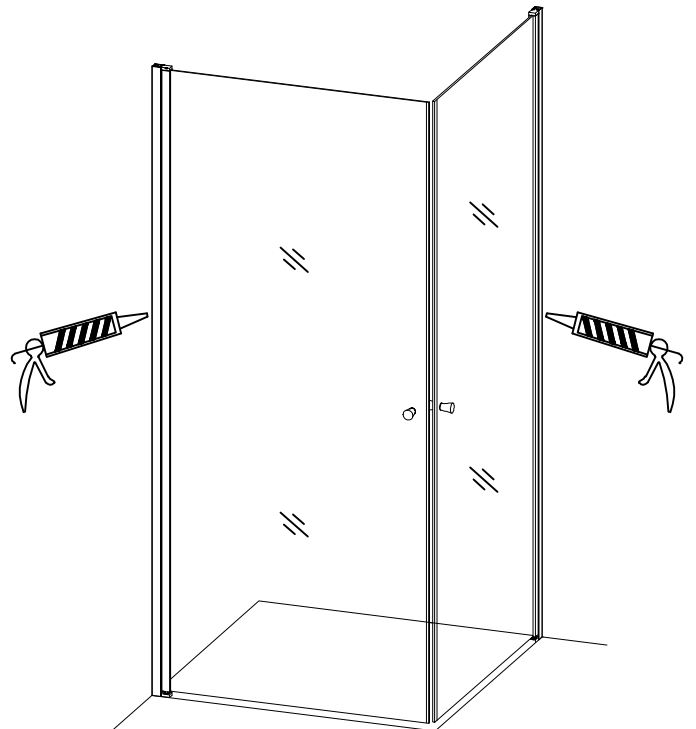

Fugning foretages udvendigt med sanitetssilikone. Hærdning efter silikoneproducentens anbefaling.